

SINGLE-PHASE MOTOR FBSP 63 B 4

AB06B4200016

General data

Type of motor	1~
Type designation	FBSP
Frame size	63
Mounting	B35
Frame material	Aluminium
Insulationclass	F/B
Terminal box location	top DE
Terminal box orientation	cable gland to the back side NDE
Weight (kg)	4.5
Rotation Direction	Clockwise
Vibration level	A
Balancing method	half key
cooling type	IC411
Executed acc. to	IEC 60034-1
noise level	IEC 60034-9

Influential factors

Duty	S1
Ambient temperature (°C)	-20 up to +40
Height of location (m)	1000

Electrical specification

Power 1 50Hz (kW)	0.18
Frequency (Hz)	50
Voltage 50Hz (V)	230
Voltage tolerance	+/-10%
Poles	4
Efficiency 100% 50Hz (%)	56,0
Power factor	0,9
Starting current factor (Ia/In)	3,1
Starting torque factor (Ma/Mn)	0,4
Breakdown torque (Mk/Mn)	0,4
Rated current 50Hz (A)	1,55

Mechanical data

Torque (Nm)	1,23
Rotation speed (1/min)	1400
Bearing DE	6201.ZZ.C3
Bearing NDE	6201.ZZ.C3
Mounting of bearing DE	loose bearing
Mounting of bearing NDE	loose bearing
Bearing lifetime (h)	20000
allow. Radial load (X/2)	375
allow. Radial load (X0)	400
allow. Radial load (Xmax)	350

Mechanical data

allow. Axial load	350
allow. Axial load (V1)	335
Moment of inertia (kgm ²)	0,00181

Motor properties

Color	RAL7030
Paint surface	shiny
Protection class	IP55
Cable gland size (cable connection)	1xM16
Cable gland type	Standard
Shaft end (mm)	11 x 23
Shaft material	C45
Specification NDE	Plastic fan
Flange	140

Motor properties Single-phase

Capacitor	BK
O.C. Capacity	10 myF/450 V

Dimension drawings

Single-phase motor FBSP 63 B 4

AB06B4200016



Die Zeichnung dient lediglich als Skizze um Maße darzustellen. Das gelieferte Produkt kann von dieser Skizze abweichen. Die detaillierte Beschreibung des Produkts befindet sich im Datenabschnitt (Seite 1).
 The drawing serves only as a sketch to show dimensions. The delivered product may differ from this sketch. The detailed description of the product can be found in the Data section (page 1).

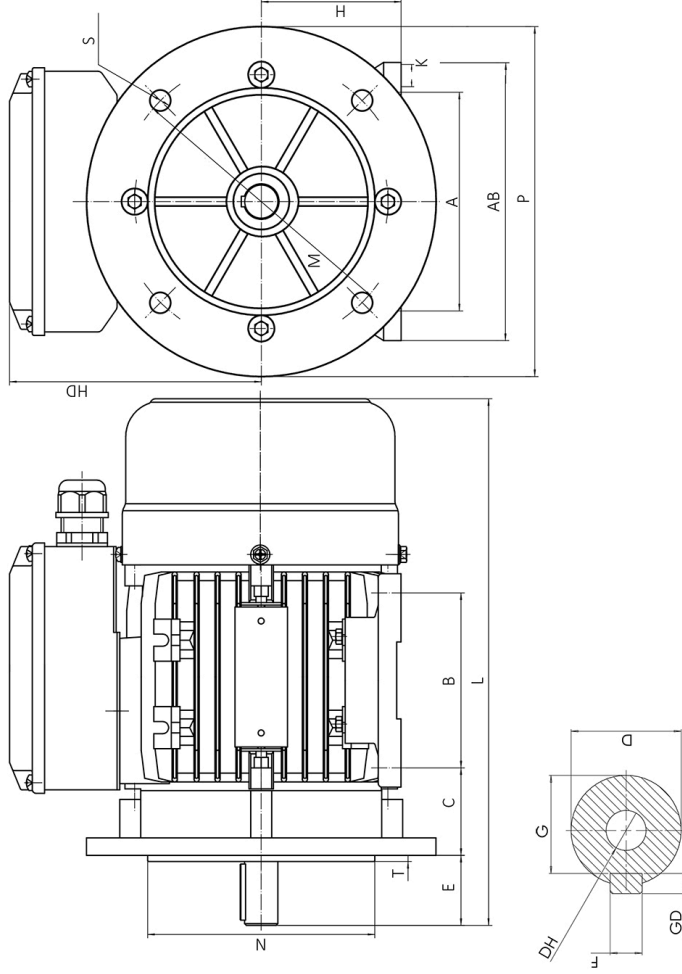

A	AB	B	C	D	E	H	HD	L	M	N	P	S	T	F	G	DH
100	130	80	40	11	23	63	122	230	115	95	140	10	3	4	8,5	M4x12