

THREE-PHASE-ASYNCHRONOUS-MOTOR FCA 112 M 2 /PHE

IE3AC11M2012N

General data

Type of motor	3~
Type designation	FCA
Frame size	112
Mounting	B5
Frame execution	M
Frame material	Aluminium
Insulationclass	F/B
Terminal box location	top DE
Terminal box orientation	cable gland to the right side
Weight (kg)	26.5
Rotation Direction	right /left
Vibration level	A
Balancing method	half key
cooling type	IC411
Executed acc. to	IEC 60034-1
noise level	IEC 60034-9

Influential factors

Duty	S1
Ambient temperature (°C)	-20 up to +40
Height of location (m)	1000

Electrical specification

Power 1 50Hz (kW)	4
Power 1 60Hz (kW)	4
Frequency (Hz)	50/60
Voltage 50Hz (V)	230/400
Voltage 60Hz (V)	265/460
Voltage/Frequency tolerance (not valid for range voltage)	+/-10%
Connection	Δ/Y
Poles	2
Efficiency 100% 50Hz (%)	88,1
Efficiency 75% 50Hz (%)	88,1
Efficiency 50% 50Hz (%)	86,3
Efficiency 100% 60Hz (%)	88,5
Efficiency 75% 60Hz (%)	88,5
Efficiency 50% 60Hz (%)	86,7
Power factor	0,88
Starting current factor	8,3
Starting torque factor	2,3
Tilting moment factor	2,3
Rated current 50Hz (A)	12,95/7,51
Rated current 60Hz (A)	11,21/6,50
Eff.Cl.50Hz	IE3

Electrical specification

Eff.Cl.60Hz	IE3
-------------	-----

Mechanical data

Torque (Nm)	13,15/10,96
Rotation speed (1/min)	2905/3486
Bearing DE	6306.ZZ.C3
Bearing NDE	6306.ZZ.C3
Mounting of bearing DE	loose bearing
Mounting of bearing NDE	loose bearing
Bearing lifetime	20000
allow. Radial load (X/2)	875
allow. Radial load (X0)	975
allow. Radial load (Xmax)	775
allow. Axial load B3,B5,B35,B14,B34	700
allow. Axial load V1,V3,V19,V18	655
Moment of inertia	0,006

Motor properties

Color	RAL7030
Paint surface	shiny
Protection class	IP55
Cable gland size (cable connection)	1xM32x1,5 1xblind plug
Cable gland size (option)	M16x1,5
Cable gland type	Standard
Shaft end	28 x 60
Shaft material	C45
Specification NDE	Plastic fan
Flange	250

Additional operating points

Voltage operating point 2	265/460
Power operating point 2 (kW)	4.8
Connection operating point 2	Δ/Y
Frequency operating point 2	60
Efficiency class operating point 2	IE2

Additional option

Protection winding	PTC 150°C
--------------------	-----------

Dimension drawings

Three-Phase-Asynchronous- Motor FCA 112 M 2 /PHE IE3AC11M2012N

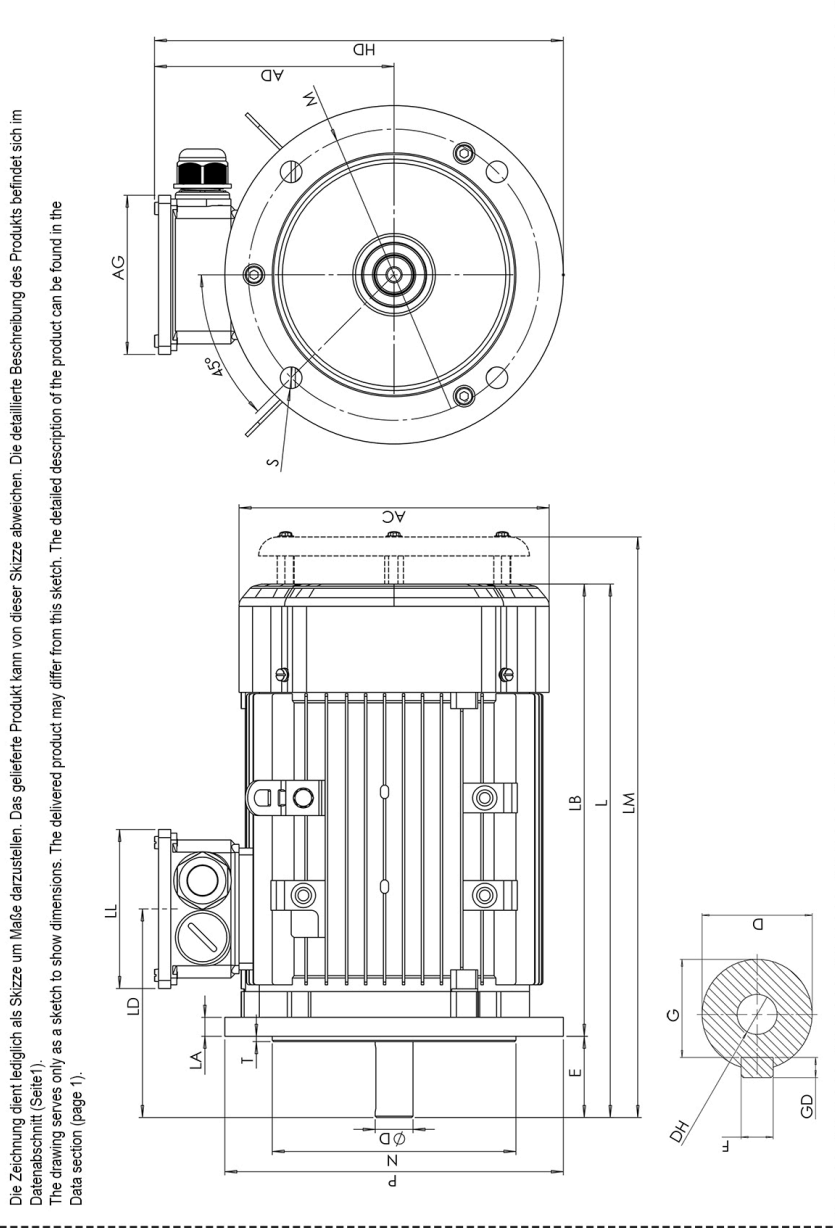

AC	AD	AG	D	E	HD	L	LM	LA	LB	LD	LL	M	N	P	S	T	F	G	DH	EB	ED	GD
214	169	118,5	28	60	294	392	432	14	332	151	118,5	215	180	250	4x14,5	4	8	24	M10x22	50	5	7